

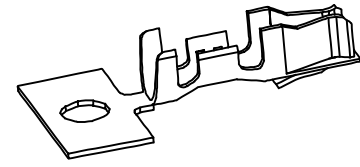

REV.	ECN NO. OR DESCRIPTION	REVISED	DATE
A1			2020-10-20

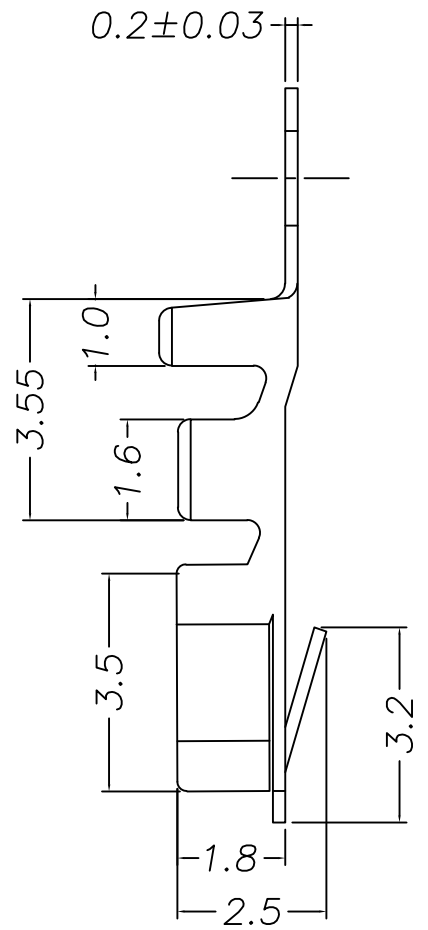
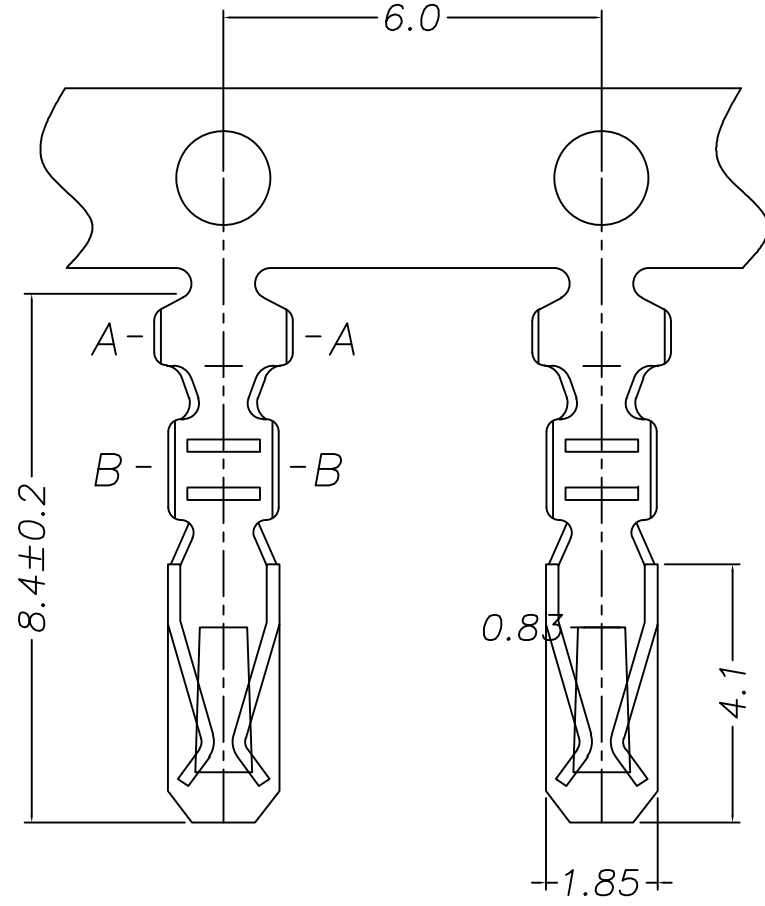
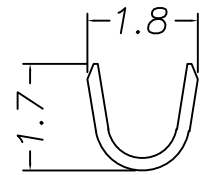
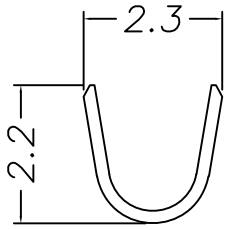

C2532TOP-2		AWG 22#~28#		1.63mm(max)		Phos.Bronze		Tin-Plated		14,000	
PART NO.		WIRE		O.D.(MAX)		MATERIAL		FINISH		Q'TY/REEL	
TOLERANCE	DRAW	BO	SCALE	1:10		 <b>UNC</b> 耀聯電子科技有限公司 UNC Electronic & Technology Co., Ltd					
	DESIGN	MA	UNIT	mm							
	X :±0.3	CHECK	LIAN	SIZE	A4		PART NO.	C2532TOP-2			
	X.X :±0.25	APPROVE	LIAN	SHEET	1of1		DESCRIPTION	SMH250-TER			
X.XX :±0.15	VERSION	J1	PROJ.								
X.XXX :±0.10											
TEL:+86-769-87299998						WEB:http://www.uniconn.cn			MAIL:uniconn@163.com		

Non-use Warranty for Level 1 Prohibited Substances In Product.

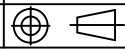