

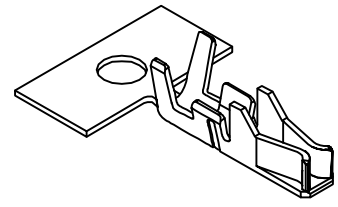

REV.	ECN NO. OR DESCRIPTION	REVISED	DATE
A1			2020-10-20

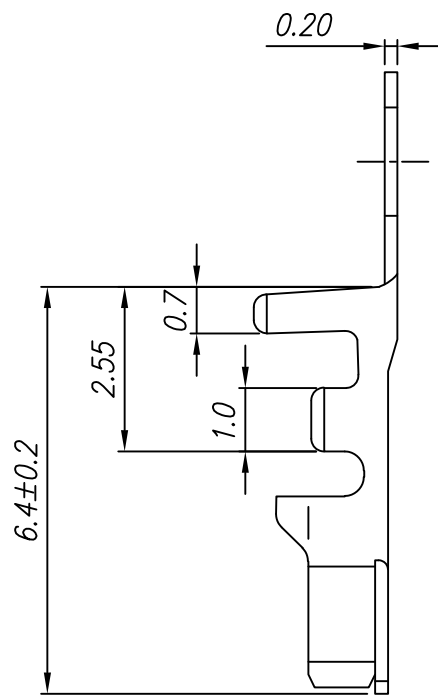
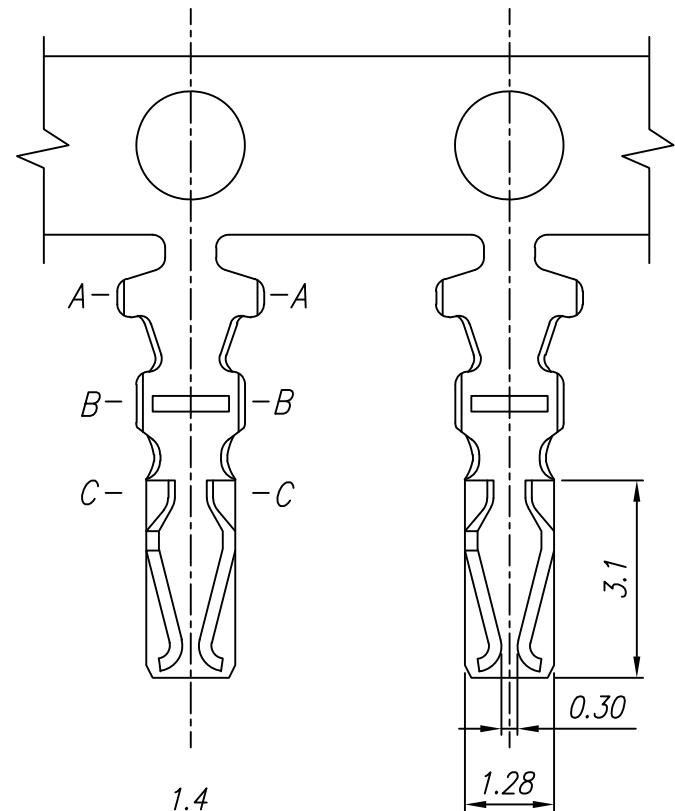
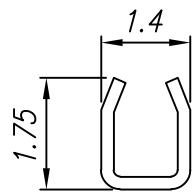
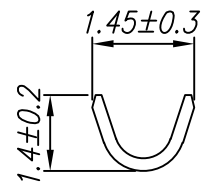
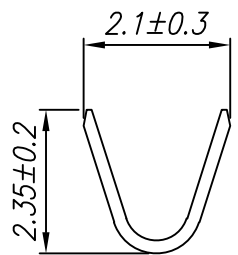
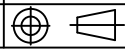

A2005TOP-2		AWG 24#~30#	1.45mm(max)	Phos.Bronze	Tin-Plated	15,000	
PART NO.		WIRE	O.D.(MAX)	MATERIAL	FINISH	Q'TY/REEL	
TOLERANCE	DRAW	BO	SCALE	1:10	 耀聯電子科技有限公司 UNC Electronic & Technology Co., Ltd		
	DESIGN	MA	UNIT	mm			
X	:±0.3	CHECK	LIAN	SIZE	A4	PART NO.	A2005TOP-2
X.X	:±0.25	APPROVE	LIAN	SHEET	1of1	DESCRIPTION	PHS2.0-TER
X.XX	:±0.15	VERSION	JD	PROJ.			
X.XXX		:±0.10	TEL:+86-769-87299998		WEB:http://www.uniconn.cn		MAIL:uniconn@163.com

Non-use Warranty for Level 1 Prohibited Substances In Product.