

RoHS

SPECIFICATIONS

Current Rating: 1A AC,DC
 Voltage Rating: 50V AC,DC
 Temperature Range: -25°C ~ +85°C
 Contact Resistance: 30mΩ Max.
 Insulation Resistance: 100MΩ Min.
 Withstanding Voltage: 500V AC/minute
 Pin Material: Phos.Bronze/Tin-plated
 Tab Material: Phos.Bronze/Tin-plated
 Material: LCP, UL94V-0
 Color: Natrue

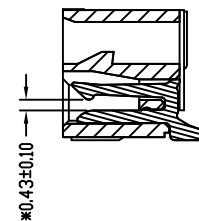
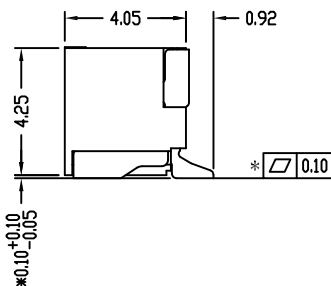
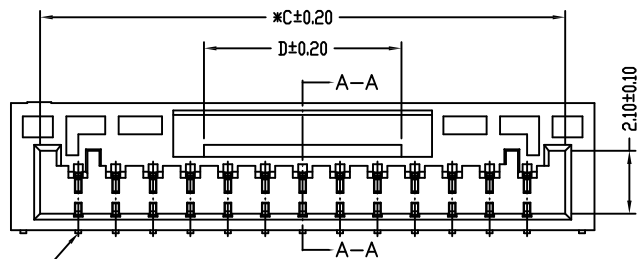
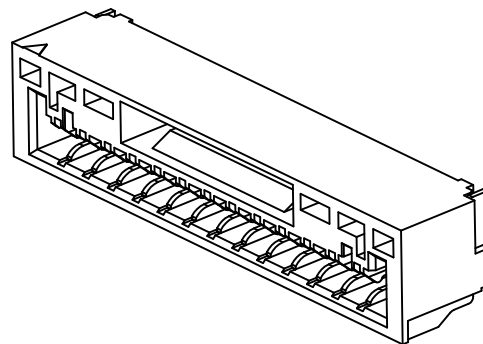
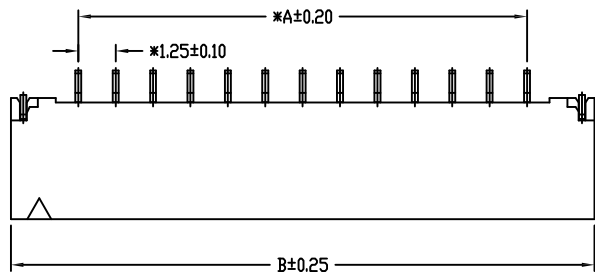

Circuit1

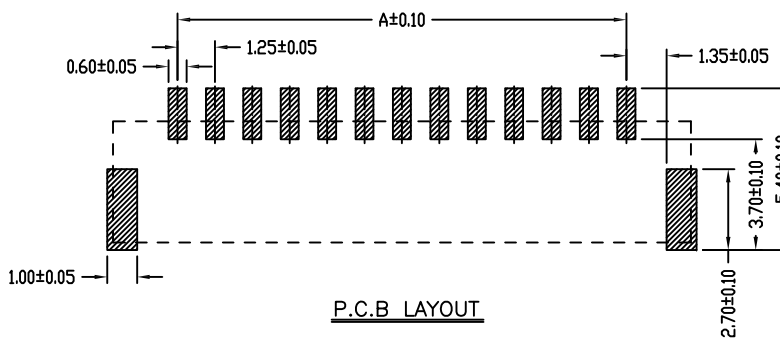
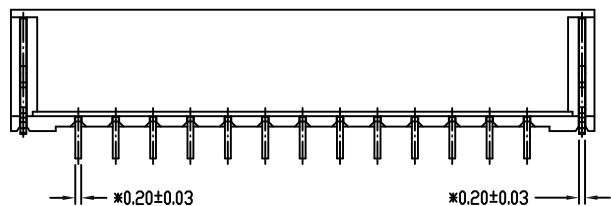

Circuits	Dimensions			
	A	B	C	D
2	1.25	5.75	3.80	0.80
3	2.50	7.00	5.05	1.60
4	3.75	8.25	6.30	2.50
5	5.00	9.50	7.55	4.65
6	6.25	10.75	8.80	4.65
7	7.50	12.00	10.05	4.65
8	8.75	13.25	11.30	4.65
9	10.00	14.50	12.55	4.65
10	11.25	15.75	13.80	6.60
11	12.50	17.00	15.05	6.60
12	13.75	18.25	16.30	6.60
13	15.00	19.50	17.55	6.60
14	16.25	20.75	18.80	6.60
15	17.50	22.00	20.05	6.60

REVISION RECORD

REV.	DATE	DESCRIPTION	CHANGE	APPROVE

TOLERANCE

.0±0.20
0.00±0.15
0.000±0.10

DRAW

DESIGN
CHECK
APPROVE
VERSION

旭信

旭信

吳奇春

吳奇春

LY1

SCALE

1:1
UNIT
SIZE
SHEET
PROJ.

1:1

mm

A4

1/1

PROJ.



耀聯電子科技有限公司
UNC Electronic & Technology Co., Ltd

PART NO.

A1257WR0-S-NP

DESCRIPTION

PITCH 1.25mm, 90°

DRAWING NO.

CRIMP TYPE, CONNECTOR

TEL:0769-87299998 FAX:0769-87299968 E-Mail:uniconn@163.com WEB:http://www.uniconn.cn